

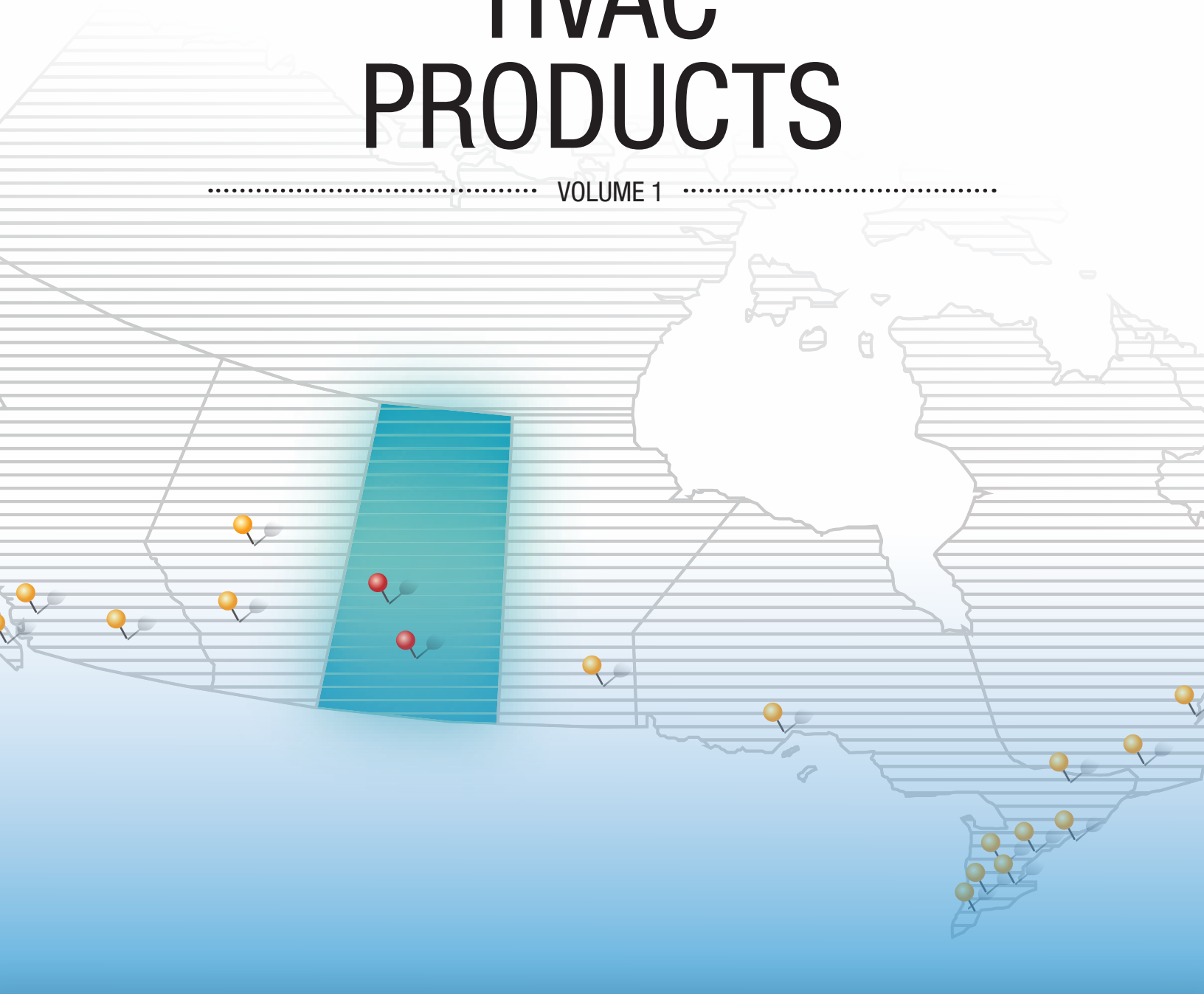

First in Quality, First in Service.

HVAC PRODUCTS

VOLUME 1



SASKATCHEWAN

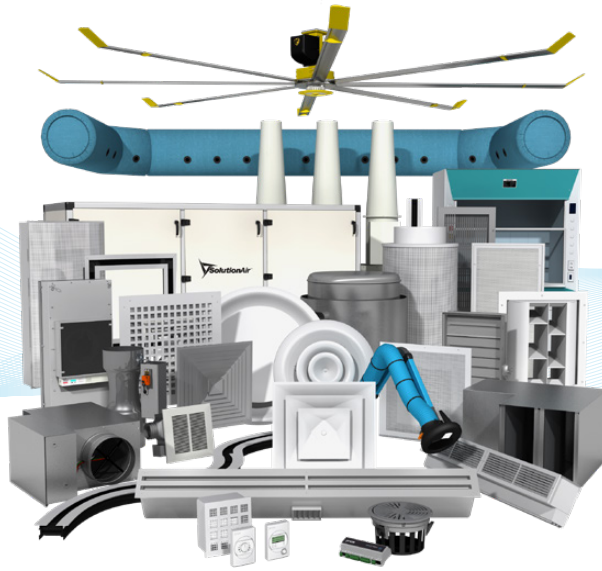

..... AIR DISTRIBUTION PRODUCTS

GRILLES, REGISTERS & DIFFUSERS



price | GRILLES

Price Industries Limited
www.priceindustries.com

price | DIFFUSERS

Price Industries Limited
www.priceindustries.com

Grilles & Registers

- Standard Grilles and Registers
- Linear Bar Grilles
- Airfoil Series Grilles and Registers
- Industrial / Special Application
- Filter Grilles
- Condo Grilles
- Nozzles
- Security Products
- Heavy Duty Gym Grilles

Linear Diffusers

- Custom Flow Linear Diffusers
- Linear Slot Diffusers

Ceiling Component Diffusers

- T-Bar Diffusers
- Light Troffer Diffusers
- Low Temperature Diffusers

Ceiling Diffusers

- Square Ceiling Diffusers
- Perforated Ceiling Diffusers
- Square and Rectangular Directional Diffusers
- Round Cone Diffusers
- VAV Diffusers

UNDERFLOOR AIR DISTRIBUTION



Price Industries Limited
www.priceindustries.com

Underfloor Air Distribution

- Round Floor Diffusers
- Linear Floor Grilles
- Linear Floor Heaters
- Power and Control Modules
- Underfloor Terminal Units
- Underfloor Deflection Grilles
- Vertical Fan Column
- Linear Floor Plenums

DISPLACEMENT VENTILATION



Price Industries Limited
www.priceindustries.com

Displacement Ventilation

- Wall Mounted Displacement Diffusers
- In-Wall Displacement Diffusers
- Free Standing Displacement Diffusers
- Floor Mounted Displacement Diffusers
- Ceiling Mounted Displacement Diffusers
- Linear Enclosure Diffusers
- Industrial Displacement Diffusers

SPECIALTY GRILLES, REGISTERS & DIFFUSERS

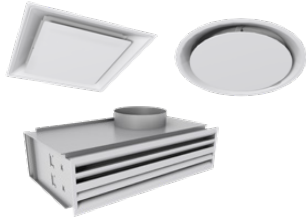

Acutherm
www.acutherm.com



Ductsox
www.ductsox.com

VAV Diffusers

- Square VAV Diffusers
- Round VAV Diffusers
- Linear VAV Diffusers

Pressure Control Products

Temperature Control Products

Air Dispersion Products

- Fabric Duct Ventilation
- Fabric Faced Diffusers
- Final Filters



Air Concepts
www.airconceptsinc.com



SEIHO International
www.seiho.com

Directional Air Distribution Products

- Punkah Diffusers
- Nozzle Diffusers
- Industrial Diffusers

Directional Air Distribution Products

- Turbo Nozzles
- Diffusers – Mini or Spot
- Grilles
- Dryer Vent Caps
- Vent Louvers

CRITICAL ENVIRONMENTS



Price Industries Limited
www.priceindustries.com

Critical Environment Products

- Ultrasuite O.R. System
- Common Plenum Laminar Array
- Hospital Grade Ceiling Systems
- Air Curtain Systems (HORD System)
- Fan Filter Units
- Laminar Flow Diffusers
- Radial Flow Diffusers
- Return and Exhaust Grilles

VENTURI VALVES, HEALTHCARE AND LABORATORY CONTROLS & MONITORS



Antec Controls
www.anteccontrols.com

Valves

- Venturi Valves – High Turndown Ratio and Mechanical Pressure Independence
- Venturi FX – Measured Airflow and Low Pressure Operation
- Integrated Venturi Valve Assembly Options
 - Performance Guaranteed Venturi with Integrated Silencer Assemblies
 - AHRI 410 Certified Venturi with Hot Water Coil Assemblies
 - UL1995 Certified Venturi with Electric Coil Assemblies

Monitors & Controls

- Room Monitors
 - Touchscreen Room Pressure Monitor – High Resolution Touchscreen Display
 - Multi-Variable Monitor – High Resolution Touchscreen Displaying up to 8 Rooms on Main Screen
 - All Monitors Have Native BACnet MS/TP Connection
- Pace™ Critical Space Controller
 - Volumetric Offset or Pressure Control
 - Temperature and Humidity Control

Fume Hood Controls

- Fume Hood Controller
 - Sash Position Sensing Fume Hood Control
 - Sidewall Sensing Fume Hood Control
 - Hybrid Fume Hood Control
 - Presence Sensing
 - Fume Hood Interface

SPECIALTY CONTAINMENT & AIR FILTRATION SYSTEMS

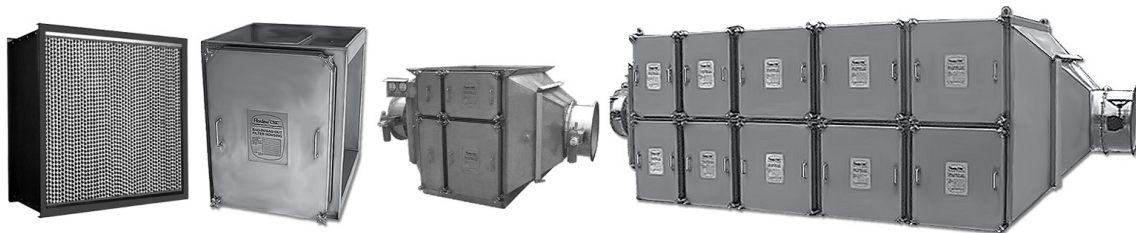

AAF Flanders
www.aafintl.com

Specialty Containment & Air Filtration Systems

- 95% DOP and HEPA / ULPA Filters
- HEPA Housings and Holding Frames
- CSC Containment Air Filtration Systems (Bag-In / Bag-Out)
- Cleanroom Ceiling Filters and Hoods

FUME HOODS

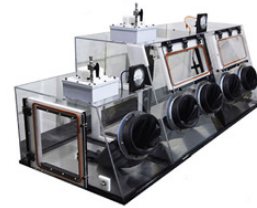

Price Industries Limited
www.ehpricesales.com



Flow Sciences
www.flowsciences.com

Fume Hood Styles Available:

- High Performance Bench Fume Hoods
- Dynamic Bench Fume Hoods
- Dynamic Walk-In Fume Hoods
- General Purpose Chemical Bench Fume Hoods
- Combination Sash Bench Fume Hoods
- Isotope Bench Fume Hoods
- Perchloric Acid Bench Fume Hoods
- General Purpose Walk-In Chemical Fume Hoods
- Base Cabinets Available
- Cupsinks, Fittings, Fixtures, Sinks and Alarms are Available for Most Fume Hood Models

Containment Enclosure Categories:

- Standard Enclosures
- Cytotoxic / HPAPI / ADC
- Pilot Plant / Manufacturing
- Multi-Task Systems
- Process Equipment / Lab Automation
- Steel Manufactured Systems
- Nanotechnology
- Benchtop / Scale Up
- Chemical Fume Hoods
- Contained Environmental Systems
- Aseptic Systems
- Compounding Hoods
- Pathology / Anatomy Workstations
- Chemical Workstations

LABORATORY EXHAUST SYSTEMS



Greenheck
www.greenheck.com

Laboratory Exhaust Systems

- High Plume Exhaust Fans
- Available in Single or Multi-Fan Arrangements
- Variable Geometry Nozzle (VGN) Technology
- Energy Recovery Systems (ERS)

TERMINAL UNITS



Price Industries Limited
www.priceindustries.com

Terminal Units

- Single Duct Terminal Units
- Bypass Controller Type Terminal Unit
- Control Valves
- Dual Duct Terminal Units
- Fan Powered Terminal Units
- Induction Terminal Units
- Retrofit Terminal Units
- Special Application Terminal Units

NOISE CONTROL

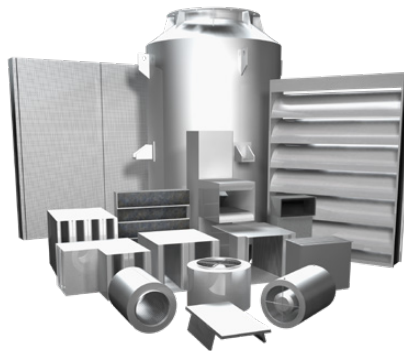

Price Industries Limited
www.priceindustries.com

Silencers

- Commercial and Custom
- Rectangular, Elbow and Circular

- Absorptive, Film-Lined and Packless
- Air Transfer and Cross-Talk

Acoustic Products

- Acoustic Panels, Enclosures and Barriers
- Acoustical Louvers

LIFE SAFETY DAMPERS



PRICE | DAMPERS

Price Industries Limited
www.priceindustries.com

GREENHECK
Building Value in Air.

Greenheck
www.greenheck.com

Life Safety Dampers

- Fire Dampers
- Combination Fire / Smoke Dampers
- Smoke Dampers
- Ceiling Radiation Dampers
- Combination Fire / Balancing Dampers

Life Safety Dampers

- Fire Dampers
- Combination Fire / Smoke Dampers
- Smoke Dampers
- Ceiling Radiation Dampers

NATURAL VENTILATION

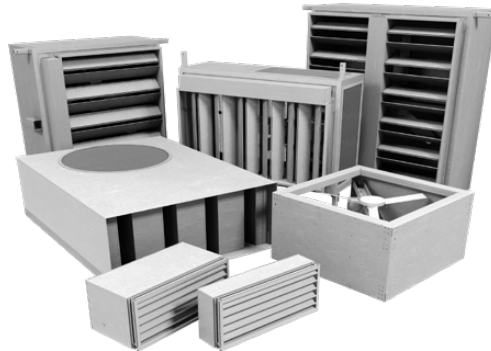

PRICE | NATURAL VENTILATION

Price Industries Limited
www.priceindustries.com

Natural Ventilation

- Natural Ventilation Roof Stack
- Roof Mounted Natural Ventilation
- Natural Ventilation Terminal
- Wall Mounted Air Transfer Unit

LOUVERS

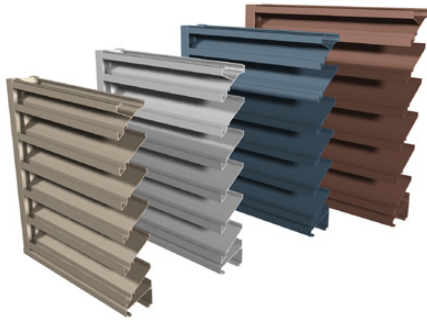

Price Industries Limited
www.priceindustries.com



Greenheck
www.greenheck.com

Louvers

- Formed Metal Louvers
- Extruded Louvers
- Standard Blade and Chevron Blade Acoustical Louvers
- Extruded Penthouse Louvers
- Formed Metal Penthouse Louvers
- Thinline Wall Application Louvers
- Rain Storm Louvers
- Wind-Driven Rain Louvers
- Sand Louvers
- Vision Screens
- Sightproof Louvers
- Louvered Shapes
- Louvered Doors
- Sunshades
- Equipment Screens
- Architectural Louvers
- Special Louvers as per Request

Louvers

- Brick Vents
- Stationary Extruded Aluminum Louvers
- Thinline Extruded Louvers
- Sightproof Extruded Louvers
- Adjustable Extruded Louvers
- Combination Extruded Louver / Dampers
- Acoustical Fabricated Louvers
- Wind-Driven Rain Resistant Extruded Louvers
- Sand Louvers
- Penthouse Louvers
- Penthouse Elevator Vent
- Equipment Screens



Air Louvers Inc.
www.airlouvers.com

Fire Rated Door Louvers

CONTROL, MANUAL & BACKDRAFT DAMPERS

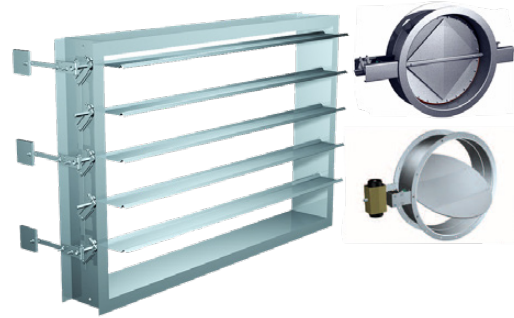
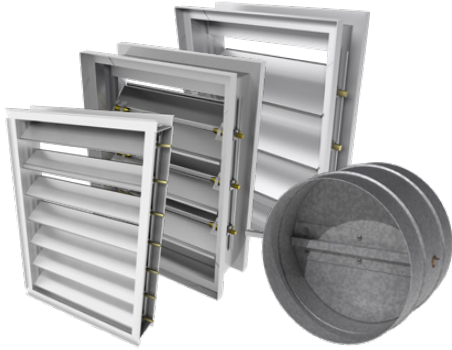

Price Industries Limited
www.priceindustries.com



Greenheck
www.greenheck.com

Dampers

- Backdraft Dampers
- Control and Balancing Dampers

Actuators

Access Doors

Dampers

- Commercial Control Dampers
- Air Measure Products
- Balancing Dampers
- Relief Dampers
- Backdraft Dampers
- Heavy Duty / Industrial Dampers

- Bubble Tight
- Tunnel Transit Dampers
- Marine Dampers

Access Doors / Pressure Relief Doors

Actuators



Young Regulator
www.youngregulator.com

Dampers

- Bowden Remote Control Dampers and Controllers
- Damper Regulators
- Manual Dampers
- Automatic Changeover Dampers
- Motorized Dampers
- Pressure Relief Dampers

COMMERCIAL & INDUSTRIAL FANS



Greenheck
www.greenheck.com

Roof Mounted Fans

- Centrifugal Roof Exhaust Fans
- Centrifugal Upblast Exhaust Fans
- Propeller Tube Axial Fans
- Centrifugal Supply Fans
- Hooded Propeller Exhaust and Supply Fans
- Recirculating Roof Fans
- Roof Curbs

Gravity Ventilators

Inline & Ceiling Fans

- Ceiling and Cabinet Fans
- Centrifugal Inline Fans
- Tubular Centrifugal Fans
- Mixed Flow Fans
- Tube Axial Fans
- Vane Axial Medium Pressure Fans
- Vane Axial High Pressure Fans
- Circulator and Mancooler Fans

Sidewall Exhaust Fans

Sidewall Propeller Fans

Utility, Centrifugal & Radial Blowers

- Utility Centrifugal Fans
- Industrial Centrifugal Fans
- Fabricated Pressure Blower
- Industrial Process Fans
- Plug Fans
- Plenum Fans
- Fiberglass Reinforced Plastic (FRP) Fans
- FumeJet Exhaust Systems

Vari-Green EC Motor Technology

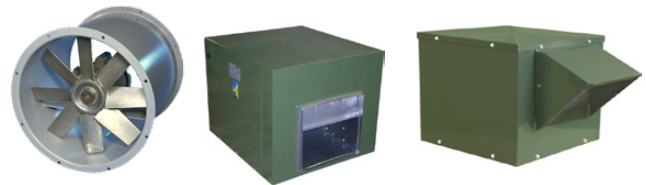
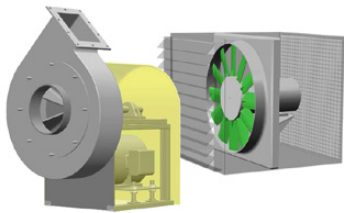

Universal Fan & Blower Ltd.
www.universalfan.com



Delhi
www.canarm.com

Industrial & Corrosion Resistant Fans

- Composite FRP / Corrosion Resistant Centrifugal and Axial Fans
- Composite FRP / Corrosion Resistant Wall Exhaust Fans
- Composite FRP / Corrosion Resistant Ductwork

Commercial Fans

- Duct Blowers
- Roof Exhausters
- Direct Drive Tube Axial
- Belt Drive Tube Axial
- Fresh Air Supply Units
- Utility Blowers
- DWDI-FC Blowers
- DWDI-BIDI Blowers

COMMERCIAL & INDUSTRIAL FANS

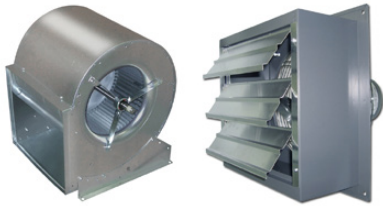

Canarm
www.canarm.com

Commercial Fans

- Wall Exhaust Fans and Circulating Fans
- Roof Exhausters
- Roof Supply
- Wall Supply / Air Make-Up
- Wall Exhausters
- Inline Duct Fan
- Man Coolers
- Circulating Fans



Broan
www.broan.ca

Commercial Fans & Range Hoods

- Range Hoods
- Bath and Ventilation Fans
- Air Exchangers



Panasonic
www.panasonic.ca

Ventilation Fans

- Advanced Ceiling Ventilation Fans
- Fan / Light Combinations
- Through-the-Wall Ventilation Fans
- Super Quiet Inline Fans



Reversomatic
www.reversomatic.com

Commercial Fans & Range Hoods

- Discharge Wall Boxes

COMMERCIAL & INDUSTRIAL FANS



GNN Fans

Ventilation Fans

- Economical Ceiling Ventilation Fans



Tjernlund
www.tjernlund.com

Commercial & Industrial Fans

- Sidewall Vent Systems
- In-Line Draft Inducers
- Ventilation Fans
- Duct Booster Fans
- In-Forcer Combustion Air Intake Systems
- In-Forcer Fresh Air Intake Systems
- Santek Electronic Air Cleaners
- Enviro-Tech Head Cooling Fans
- Variable and Fixed Speed Engineer Specified Systems
 - Intelligent Exhaust and Ventilation Systems
 - Constant Pressure Controller
 - Modulating Draft System for Boilers and Water Heaters
 - Modulating Combustion and Make-Up Air Systems
 - Modulating Dryer Venting Systems



Fantech
www.fantech.net

Commercial Fans

- Inline Duct Fans
- Bathroom / Kitchen Exhaust Fans
- Round Backdraft Dampers
- Lint Traps
- Heat Recovery Ventilators

COMMERCIAL & INDUSTRIAL FANS



Plastec Ventilation, Inc.
www.plastecvent.net

-fanAm-

FANAM Inc.
www.fanam.com

Corrosive Resistant Polypropylene Fans & Blowers

- Centrifugal Fans
- Inline Centrifugal Fans

Stainless Steel Blowers

Corrosive Resistant Polypropylene Fans & Blowers

- Centrifugal Blowers
- Roof Exhausters
- Inline Blowers
- Ceiling Exhaust

KITCHEN VENTILATION SYSTEMS



Greenheck
www.greenheck.com

Exhaust Hoods

- Wall Canopy Hoods
- Backshelf Hoods
- Single Island Canopy Hoods
- Heat and Condensate Hoods
- Fire Ready Range Hood
- Filtration Options
- External Supply Plenums
- Exhaust Hood Options and Accessories

Controls & Energy Management

- Demand Controlled Kitchen Ventilation
- Fan Control Centers
- Temperature Interlock Controls

Fire Suppression Systems

- ANSUL R-102
- ANSUL R-102 Overlapping
- ANSUL Piranha
- Amerex KP
- Amerex Zone Defense
- Fire Suppression Systems Options and Accessories

Utility Distribution Systems

- Utility Distribution System
- Utility Distribution System Options and Accessories

Pollution Control Units

- Grease Trapper
- Grease Trapper ESP

Exhaust Fans

Make-Up Air Units

Packaged Rooftop Units

Grease Duct

- Duravent Zero Clearance - UL 2221
- Duravent Single and Double Wall - UL 1978

COMMERCIAL CEILING DESTRATIFICATION FANS



BIG ASS FANS®

Big Ass Fans
www.bigassfans.com



Greenheck
www.greenheck.com

Large Fans For Commercial, Industrial, Governmental & Agricultural Applications

- Summer Cooling
- Winter Destratification / Heat Recirculation
- High Volume, Low Speed Fans
- 6' to 24' in Diameter

Ceiling Destratification Fans

- Year-Round Comfort in Air Circulation and Destratification
- High Volume, Low Speed Fans
- Fan Diameters Between 8' to 24'



Canarm
www.canarm.com



BANVIL 2000

Banvil 2000 Envirofan
www.envirofan.com
www.banvil2000.com

Industrial High Performance Ceiling Fans

Ceiling Destratification Fans Industrial Ceiling Fans

HEAT RECOVERY VENTILATORS & ENERGY RECOVERY VENTILATORS

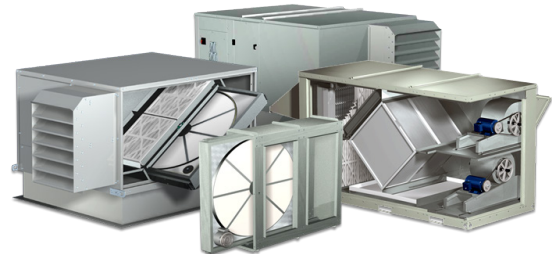

SolutionAir
www.solutionairgroup.com



Greenheck
www.greenheck.com

RegenCore Alternating Mass-Exchanger Energy Recovery Units

- With No Pre-Heat Requirements Down to Outdoor Temperatures of -40°C
- Up to 92% Effectiveness

Energy Recovery Ventilators

- Preconditioners
- ERV with Cooling and Heating
- Energy Recovery Modules
- Control Options for Energy Recovery Ventilators

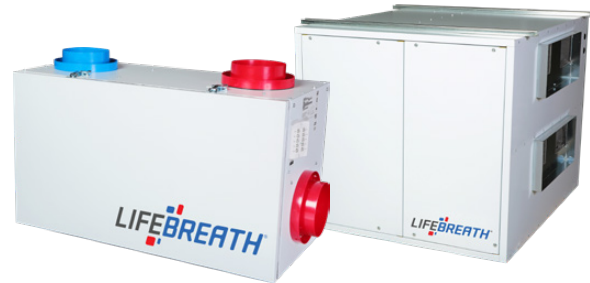
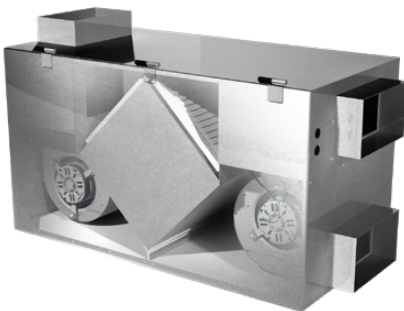

Nu-Air
www.nu-airventilation.com



Lifebreath
www.lifebreath.com

Residential / Commercial HRVs & ERVs

- Air Exchangers, Passive HRVs and Wet Basement Solutions
- Controls and Accessories

Inline Fans

- Heat Recovery Ventilators
- Turbulent Flow Precipitators
- Clean Air Furnace

ELECTRIC HEATERS



Neptronic
www.neptronic.com

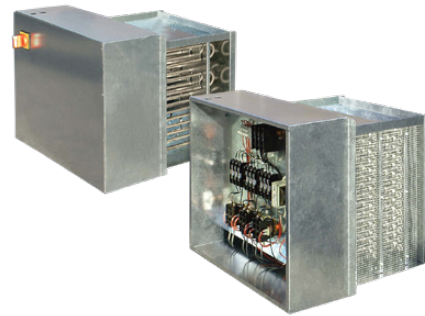

Price Industries Limited
www.priceindustries.com

Electric Duct Heaters

- Open or Tubular Coils

Electric Duct Heaters

- Open or Tubular Coils



Ouellet Electric Heating
www.ouellet.com

Residential / Commercial / Industrial / Architectural Electrical Heating Products

- Baseboard Heaters
- Wall Heaters
- Unit Heaters
- Portable Heaters
- Radiant Heaters
- Draft Barriers
- Cabinet Convector

AIR FILTRATION PRODUCTS



AAF Flanders
www.aafintl.com

Air Filtration Products

- Disposable Air Filters
- Media Pads and Rolls
- Paint Booth Filters
- Odor Control Filters
- Carbon Absorbers
- Pleated Filters
- Medium and High Efficiency Rigid Type Air Filters
- Medium and High Efficiency Extended Surface Type Bag Filters
- ASHRAE Side Access Housings and Holding Frames
- Gaseous / Vapor Phase Side Load and Front Load Housings

GAS DETECTION



Honeywell Analytics
www.honeywellanalytics.com

Commercial Gas Detection Systems

- Monitors, Controllers and Hand Held Products

UV PURIFICATION SYSTEMS



SANUVOX

Sanuvox Technologies
www.sanuvox.com

Ultraviolet Air & Object Purification Systems

- Residential, Commercial and Industrial Applications
- In-Duct or Stand Alone Ultraviolet Air Purifiers
- Ultraviolet Object Purifiers for Mold and Bacteria on Evaporator Coils
- Specialty UV Products

DUST COLLECTION

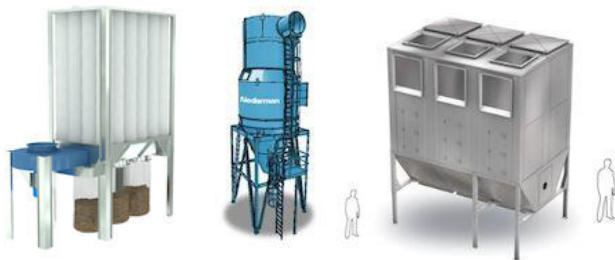

Nederman
IMPROVING YOUR WORKSPACE

Nederman
www.nederman.com

Donaldson.
Filtration Solutions

Donaldson (Torit)
Filtration Solutions
www.donaldson.com

Dust Collectors

- Baghouse Dust Collectors
- Cartridge Dust Collectors
- Cyclone Dust Collectors

Industrial Dust, Fume & Mist Collectors

- Cartridge Collectors
- Powercore Collectors
- Baghouse Collectors
- Cyclone Collectors
- Fume Collectors
- Mist Collectors
- Wet Scrubbers
- Downdraft Tables
- Grinding Booths
- Replacement Media

FUME & VEHICLE EXTRACTION



Nederman
www.nederman.com



Sourcetec
www.sourcetecindustries.com

Fume & Vehicle Extraction

- Fume Extraction Arms and Fans
- Bench Top Flexible Extraction Arms and Fume Cabinets
- Filter Carts and Filter Box Mobile Fume Extractors
- Vehicle Exhaust Fume Extractors and Hose Reels
- Fume Extraction Rail Systems
- Electrostatic and Oil Mist Filters
- Magna Track Fire Station Exhaust Extractors for Rescue Vehicles

Automotive Exhaust Equipment

Industrial Cleaning Solutions

Air Cleaning Systems

AIR & GAS PURIFICATION



Unisorb Canada
www.unisorb.ca

Air & Gas Purification

- Corrosion and Odor Control
- Environmental Emission Control
- Personnel Protection

AIR CURTAINS



Berner International
www.berner.com

Architectural, Commercial, Retail & Industrial Air Curtains

- Sanitation Certified Air Curtains for Restaurants
- Hazardous Location Air Curtains Available for Manufacturing Plants, Bus Garages and Pharmaceutical Plants



Thermoscreens
www.thermoscreens.ca

Commercial, Retail & Industrial Air Curtains



Enershield Air Barriers
www.enershield.ca

Commercial, Retail & Industrial Air Barriers

- Vertical and Horizontal Installations Available
- Air Barriers for All Applications
 - Shipping and Receiving Doors
 - Service Bays
 - Personnel and Retail Doors
 - Coolers
 - Food Prep
 - Manufacturing
 - Warehouse and Distribution

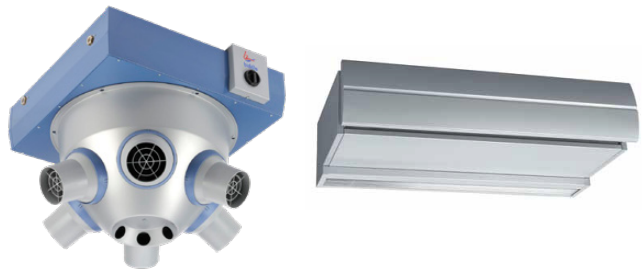

Biddle Climate Solutions
www.biddle.ca

Commercial, Retail & Industrial Air Curtains NOZ Adjustable Nozzle Unit Heater for High Induction

VIBRATION ISOLATION



The VMC Group
www.thevmcgroup.com

Vibration Isolation

- Floor Mounted Isolators
- Bases, Rails and Brackets
- Hangers
- Pad-Type Isolators
- Flexible Connectors
- Piping Specialties
- Seismic Products
- Floating Floor

FLEXIBLE DUCT



Thermaflex
www.thermaflex.net

Flexible Hose Products for HVAC

CONTROLS



PRICE | CONTROLS

Price Industries Limited
www.priceindustries.com



Carrier
www.carrier.com

Application Specific Controls for:

- Networked or Stand-Alone Applications
- VAV / VVT Controllers (BTL Certified)
- Mini-Front-End Solutions

Pneumatic Stand-Alone Controls

Control Applications:

- Rooftop Controls
- Bypass Controls
- Single Duct Controls
- Fan Powered Controls
- Prodigy Smart Diffusers
- Web Server Graphical Interface
- Hydronic Controls
- Underfloor Controls

Fully Integrated Light Commercial & Commercial DDC Systems Including:

- Operator Interface
- Programmable Controllers
- Zoning Systems
- Network Devices
- Sensors



BELIMO

Belimo
www.belimo.ca

KMC
CONTROLS

KMC Controls
www.kmc-controls.com

Electric Damper Actuators

Pneumatic Actuators & Controls
Electric Actuators & Controls

VFDs & STARTERS



Franklin Control Systems
www.franklin-controls.com

HVAC Specialty Products

- Building Automation Starters
- Standard Automation Starters
- Cooling Tower Controls
- Kitchen Hood Controls
- Pump and HVAC Controls

Industrial Products

- Contactors and Overload Relays
- Manual Motor Starters
- Circuit Breakers
- Starters
- Soft Starters
- Soft Starters with Integrated Bypass

- Programmable Logic Controllers
- Terminal Blocks
- Pilot-Devices
- Enclosures



PRESSURE GAGES & METERS



Dwyer
www.dwyer-inst.com

Pressure Gages & Manometers

- Air Velocity Meters
- Flow Transmitters, Sensors, Meters and Indicators
- Level Indicators, Detectors and Controllers
- Temperature Controllers
- Valves
- Air Quality Instruments
- Hazardous Rated
 - Valves
 - Temperature Transmitters
 - Pressure Switches
 - Flow Products
 - Level Models
 - Pressure Transmitters
- Test Equipment



MECHANICAL PRODUCTS

CHILLERS



Carrier
www.commercial.carrier.com

Water-Cooled Chillers

- Rotary Hermetic Centrifugal: 200 – 3,400 Tons
- High Efficiency Variable Speed Screw: 175 – 550 Tons
- Rotary Screw: 75 – 400 Tons
- Packaged Scroll: 15 – 71 Tons

Air-Cooled Chillers

- Packaged Scroll: 10 – 390 Tons
- Packaged Screw: 80 – 500 Tons
- Remote Air-Cooled Scroll: 15 – 71 Tons
- Remote Air-Cooled Screw: 70 – 265 Tons
- High Efficiency Variable Screw: 140 – 500 Tons

Modular Chillers

- Module Sizes from 15 – 70 Tons
- Up to 8 Modules Can be Combined for a Total Capacity of 560 Tons



Aermec
www.aermec.us

Water-Cooled Chillers

- Cool Only: 15 – 139 Tons
- Heat Pump: 15 – 139 Tons
- Simultaneous Heat / Cool: 31 – 129 Tons
- Modular: 31 Tons (Up to 32 Modules)

Air-Cooled Chillers

- Cool Only: 6.5 – 261 Tons
- Heat Pump: 2 – 261 Tons
- Simultaneous Heat / Cool: 12 – 240 Tons
- Free Cooling: 13 – 236 Tons
- Modular: 29 Tons (Up to 9 Modules)

COOLING TOWERS & FLUID COOLERS



Coil Company
www.coilcompany.com

Fluid Coolers

- Single and Double Wall Fan Units

COPPER-SILVER IONIZATION SYSTEMS



Liquitech Environmental
Solutions
www.liquitech.com



H2o Biotech Water Treatment
Technologies
www.h2obiotech.com

Copper-Silver Ionization Systems for Clean, Safe Water
Systems in Hospitals, Hotels & Other Facilities

Copper-Silver Ionization
UV Ozonation

SPLIT SYSTEMS



Carrier
www.commercial.carrier.com

Condensing Units

- Air-Cooled Scroll Up to 130 Tons

Condensers

- Air-Cooled Up to 200 Tons

PACKAGED INDOOR SYSTEMS



Carrier
www.commercial.carrier.com

Self-Contained

- Water-Cooled Units: 5 – 100 Tons
- Air-Cooled Units: 3 – 20 Tons
- Remote Air-Cooled Units: 5 – 60 Tons

PTAC

- Vertical Packaged Terminal Air Conditioners: 9,000 – 24,000 Btuh

MAKE-UP AIR UNITS



SolutionAir
www.solutionairgroup.com



Greenheck
www.greenheck.com

Make-Up Air Units

- Direct Fired: 250 – 15,000 MBH
- Indirect Fired Drum and Tube: 200 – 6,000 MBH
- Indirect Fired Convolute Tube: 75 – 1,200 MBH
- 90% Efficient Indirect Fired: 250 – 1,600 MBH

Make-Up Air Units

- Commercial and Industrial
- Kitchen Systems
- Direct and Indirect Gas Fired
- Indoor and Outdoor Construction
- Heating Options: Electric, Steam and Hydronic
- Cooling Options: Hydronic and DX (Packaged or Split)

DOAS (DEDICATED OUTSIDE AIR SYSTEMS)



SolutionAir
www.solutionairgroup.com

Air-Cooled DOAS Units

- Up to 20,000 CFM
- Heating Options: Gas, Electric, Steam and Hydronic
- Cooling Options: Hydronic and DX (Packaged or Split)
- Energy Recovery Options



Carrier
www.commercial.carrier.com

Air-Cooled DOAS Units

- 700 – 9,000 CFM
- Heating Options: Gas, Electric, Steam and Hydronic
- Energy Recovery Options

Water Source Heat Pump DOAS Units

- 700 – 9,000 CFM
- Heating Options: Gas, Electric, Steam and Hydronic
- Energy Recovery Options



Greenheck
www.greenheck.com

Air-Cooled, Water-Cooled & Water Source Heat Pump DOAS Units

- 800 – 13,500 CFM
- Heating Options: Gas, Electric and Hydronic
- Cooling Options: Hydronic and DX (Packaged or Split)
- Energy Recovery Options

AIR HANDLERS



Carrier
www.commercial.carrier.com

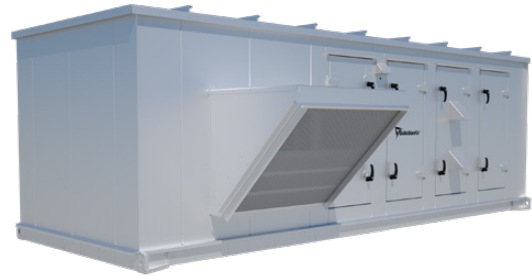

SolutionAir
www.solutionairgroup.com

Air Handlers

- Custom Double Wall Indoor / Outdoor Units: 1,500 – 60,500 CFM
- Compact Single / Double Wall Indoor / Outdoor Units: 400 – 8,500 CFM
- Compact Single / Double Wall Indoor Only Units: 1,800 – 15,000 CFM
- Heating Options: Gas, Electric, Steam and Hydronic
- Cooling Options: Hydronic and DX
- Energy Recovery Options



Greenheck
www.greenheck.com

Indoor Air Handlers

- 300 – 4,700 CFM
- Heating Options: Steam and Hydronic (Electric Heat Available on Some Models)
- Cooling Options: Hydronic and DX

Air Handlers

- Up to 100,000 CFM
- Indoor / Outdoor Construction
- Single / Double Wall Construction
- Heating Options: Gas, Electric, Steam and Hydronic
- Cooling Options: Hydronic and DX (Packaged or Split)
- Energy Recovery
- Packaged Controls



Coil Company
www.coilcompany.com

Air Handlers

- 800 – 12,000 CFM
- Indoor / Outdoor Construction
- Single / Double Wall Construction
- Heating Options: Electric, Steam and Hydronic
- Cooling Options: Hydronic and DX

AIR HANDLERS

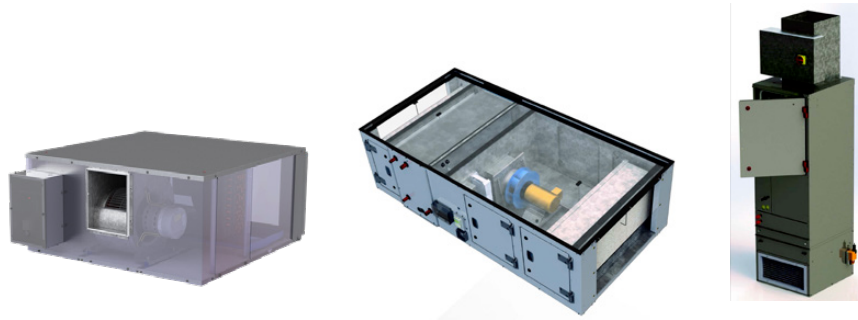

Magic Aire

Magic Aire
www.magicaire.com

Air Handling Units

- Belt-Drive Multi-Positional Modular: 800 – 8,000 CFM
- Horizontal One-Piece: 400 – 8,000 CFM
- Roof Mounted: 800 – 8,000 CFM
- Vertical: 800 – 4,000 CFM
- Horizontal Critical Environment: 400 – 2,500 CFM

CUSTOM AIR HANDLERS

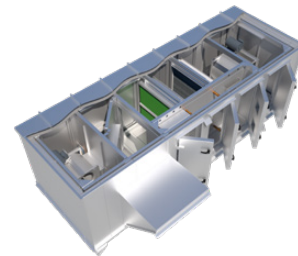
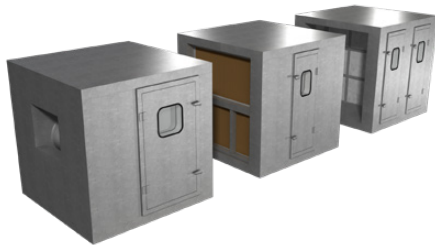

RACAN  **Racan / Carrier**
 Custom Air Handling Solutions
www.racan-carrier.ca

 **SolutionAir**
www.solutionairgroup.com

Custom Air Handlers

- 1,000 – 300,000+ CFM
- Custom Solutions for Retrofit and New Construction
- Central Station Air Handlers
- Air Handlers in Any Configuration
- Knock-Down AHU Construction
- Heating Options: Gas, Electric, Steam and Hydronic
- Cooling Options: Hydronic and DX (Packaged or Split)
- Fan Array
- Integrated Controls

Custom Air Handlers

- Up to 100,000 CFM
- Indoor / Outdoor Construction
- Single / Double Wall Construction
- Heating Options: Gas, Electric, Steam and Hydronic
- Cooling Options: Hydronic and DX (Packaged or Split)
- Energy Recovery
- Packaged Controls

HORTICULTURAL UNITS

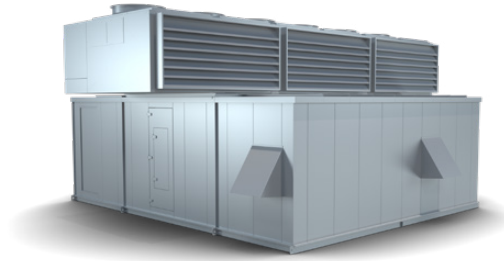

SolutionAir
www.solutionairgroup.com

Proven Solution Specifically Engineered for the Indoor Horticultural Environment

- Precision Temperature and Humidity Control
- Energy-Saving Design
- Failsafe Operation with Redundant Components
- Variable Capacity Constant Load Operation
- Low Ambient Cooling
- Patented Thermally Broken Design
- Marine-Grade Aluminum Cabinet Extends Product Life Cycle By Protecting Against Oxidization and Galvanic Corrosion
- Options:
 - UV Lights
 - Positive Pressurization
 - CO2 Purge
 - CO2 Injection
 - Condensate Management

ROOFTOP UNITS



Carrier
www.commercial.carrier.com

Rooftop Units (20 – 150 Tons)

- Constant Volume Rooftop Units with Gas or Electric Heat or Cooling Only
- Variable Volume Rooftop Units with Gas or Electric Heat or Cooling Only
- Rooftop Dedicated Outdoor Air Units up to 35 Tons



Greenheck
www.greenheck.com

Packaged Rooftop Units (5 – 45 Tons)

- Heating Options: Indirect Gas, Electric, Steam and Hydronic
- Cooling Options: Hydronic and DX (Packaged or Split)
- Energy Recovery Options



SolutionAir
www.solutionairgroup.com

Rooftop Units (8 – 250 Tons)

- Highly Configurable
- Heating Options: Indirect Gas, Electric, Steam and Hydronic
- Cooling Options: Hydronic and DX (Packaged Up to 160 and Split Up to 250 Tons)
- Energy Recovery Options

ROOFTOP UNIT ACCESSORIES

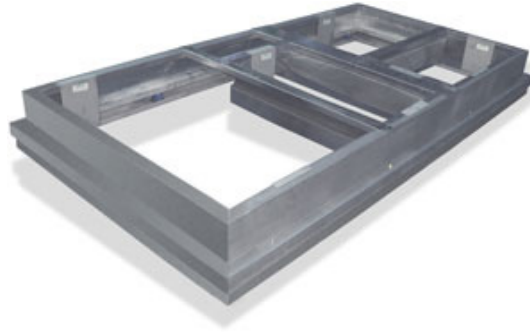

Spinner
www.spinnerindustries.com

Rooftop Unit Accessories

- Roof Curbs
- Economizers
- Step Down Diffusers

Air & Water-Cooled Self-Contained AC Units

CHILLED BEAMS

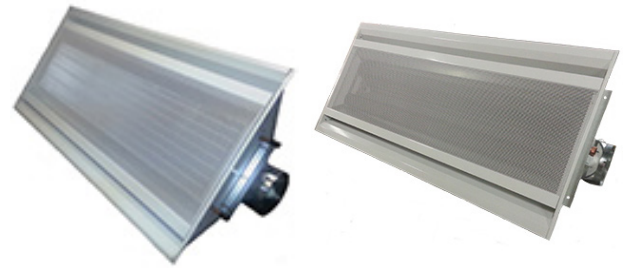

Price Industries Limited
www.priceindustries.com



Carrier
www.commercial.carrier.com

Chilled Beams

- Linear, Modular, Horizontal, Vertical and Floor-Mounted Active
- Linear Passive
- Passive with Integrated Returns
- Controls and Hose Kits

Retrofit Perimeter Induction Units

Active Chilled Beams Induction Beams

INDUCTION UNITS



Carrier
www.commercial.carrier.com

Induction Units

- 2-Pipe Bypass Control: 20 – 130 CFM
- 2 or 4-Pipe Water Control: 20 – 130 CFM
- 2-Pipe Bypass Control with Electric Heat: 20 – 130 CFM

FAN COILS

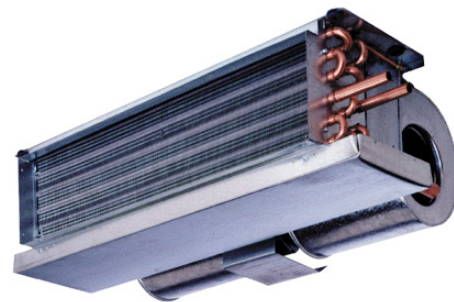
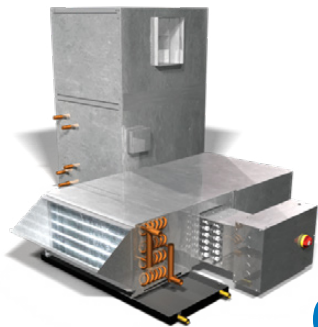

PRICE FAN & BLOWER COILS

Price Industries Limited
www.priceindustries.com



Carrier
www.commercial.carrier.com

High Performance Fan Coils

- Optional Integrated Silencer
- Standard ECM Motor

Horizontal Blower Coils

Vertical Fan Coils

- Concealed and Exposed

Fan Coils

- Belt-Drive: 600 – 4,000 CFM
- Ducted: 600 – 2,000 CFM
- Horizontal: 600 – 1,200 CFM
- Stack: 300 – 2,000 CFM
- Vertical: 200 – 1,200 CFM
- Hydronic Cassette: 200 – 1,200 CFM

FAN COILS



Greenheck
www.greenheck.com



Aermec
www.aermec.us

High Performance Fan Coils

Fan Coil Units

- Universal Room Mount: 0.28 – 2.45 Tons
- Ducted Hide-Away: 0.28 – 2.45 Tons
- Highwall: 0.54 – 1.08 Tons
- Cassette: 1.70 – 3.12 Tons
- Multi-Zone Distribution Plenum

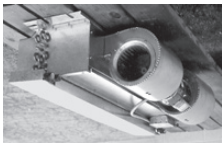

Magic Aire
www.magicaire.com



Coil Company
www.coilcompany.com

Fan Coil Units

- Direct-Drive Multi-Position: 600 – 2,000 CFM
- Direct-Drive Horizontal: 400 – 1,000 CFM
- Direct-Drive Vertical: 400 – 1,000 CFM
- Direct-Drive Horizontal Cased: 200 – 1,200 CFM
- Direct-Drive Horizontal Uncased: 200 – 1,200 CFM
- Floor Mount Console: 200 – 1,200 CFM

Fan Coil Units

- Horizontal: 200 – 2,200 CFM
- Vertical: 200 – 1,200 CFM
- Vertical Utility / Closet Units: 400 – 1,200 CFM

UNIT VENTILATORS

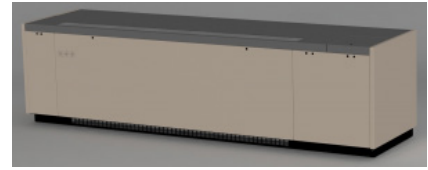
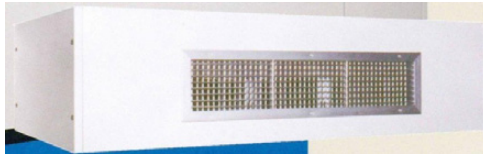
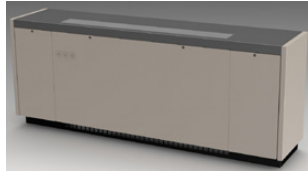

Magic Aire

Magic Aire
www.magicaire.com

Unit Ventilators

- Vertical – Floor Mounted: 500 – 1,500 CFM
- Horizontal – Ceiling Suspended: 750 – 2,000 CFM

DEHUMIDIFICATION UNITS



Bry-Air
www.bry-air.com

Ultra-Low Dewpoint Dehumidification (300 – 30,000 CFM)

Add-On Dehumidification Section for Custom or Commercial AHU (300 – 30,000 CFM)

Standard Desiccant Dehumidifiers (100 – 1,200 CFM)

HYDRONIC HEAT & UNIT HEATERS



Vulcan Radiator
www.vulcanrad.com



Price Industries Limited
www.priceindustries.com

Commercial Hydronic Heating

- Commercial Wall-Fin Radiation
- Light Commercial Wall-Fin Radiation
- Cabinet Unit Heaters
- Convectors
- Horizontal and Vertical Unit Heaters
- Panel Radiators
- Custom Enclosure
- Security Enclosure



Radiant Heating & Cooling Systems

- Linear Ceiling Panels
- Modular Ceiling Panels
- Security Ceiling Panels
- Custom Ceiling Panels



Sterling HVAC Products
www.sterlinghvac.com

Commercial Gas Heating

- Gas Fired Unit Heaters
- Gas Fired Duct Furnaces

Commercial Hydronic Heating

- Hydronic Unit Heaters
- Cabinet Unit Heaters
- Convectors
- Wall-Fin

COILS



Greenheck
www.greenheck.com



Coil Company
www.coilcompany.com

Coils

- Chilled Water
- Hot Water
- DX Evaporator
- Heat Reclaim
- Condenser
- Standard Steam
- Non-Freeze Steam Distributing
- Booster / Duct Mounted

HVAC Coils

- Chilled Water
- Hot Water
- Steam
- DX
- Condenser

Heavy Duty Industrial Coils Booster Coils

HEAT PUMPS



Florida Heat Pumps
www.bosch-climate.us



Carrier
www.commercial.carrier.com

Heat Pumps

- Split: ½ – 6 Tons
- Water-to-Water: 2 – 35 Tons
- Water-to-Air: ½ – 60 Tons
- Geothermal: ½ – 60 Tons
- Roof Top: 4 – 30 Tons
- Console: ¾ – 1 ½ Tons

Water Source Heat Pumps

- Horizontal: ½ – 20 Tons
- Vertical: ½ – 30 Tons
- Console: ¾ – 1 ½ Tons
- Water-to-Water: 2 – 35 Tons



Aermec
www.aermec.us

Air-to-Water Heat Pumps

- Outdoor Mounted Heat Pump: 2 – 261 Tons
- Indoor Mounted Heat Pump: 15 – 90 Tons
- Simultaneous Heat / Cool: 12 – 240 Tons

Water-to-Water Heat Pumps

- Heat Pump: 15 – 139 Tons
- Simultaneous Heat / Cool: 31 – 129 Tons

VARIABLE REFRIGERANT FLOW (VRF)



LG HVAC
www.lgvrf.ca

Variable Refrigerant Flow

- Indoor Fan Coils
 - 5,500 – 95,000 Btuh Cooling
 - 6,100 – 107,500 Btuh Heating
 - Wall Mounted, 1-Way, 2-Way or 4-Way Cassette, Ceiling Concealed, Floor Standing or Vertical
- Air Source
 - Heat Pump and Heat Recovery Up to 42 Tons per System (Available in 575V)
 - Up to 64 Indoor Units
- Water Source
 - Heat Pump and Heat Recovery Up to 42 Tons per System
 - Up to 64 Indoor Units

SPLIT SYSTEM AIR CONDITIONERS



LG HVAC
www.lgdfs.ca

Split Systems Air Conditioners

- Ducted Split Systems
 - Condensing Units: 9,000 – 54,000 Btuh
 - -40°F Cooling Capability
 - Air-Cooled Heat Pump or Cooling Only Options
 - Single and Multi-Zone Capabilities
 - Fan Coils: 9,000 – 54,000 Btuh
 - Ceiling Concealed
 - Single and Multi-Zone Capabilities
- Ductless Split Systems
 - Condensing Units: 9,000 – 54,000 Btuh
 - -40°F Cooling Capability
 - Single and Multi-Zone Capabilities
 - Fan Coils: 9,000 – 54,000 Btuh
 - Wall or Ceiling Mount
 - Single and Multi-Zone Capabilities

Packaged Terminal Air Conditioners

- Horizontal Wall Mount Packaged Terminal Air Conditioner: 7,000 – 15,000 Btuh
- Optional Electric Heat

CHIMNEYS



ICC Chimney
www.icc-chimney.com

Chimneys

- Condensing Vent Sizes 5” Through 24”
- Single Wall, Double Wall and Insulated
- UL Listed for Category I, II, III, IV Gas Fired Appliances
- AL29-4C or 444 Stainless Steel Construction
- Canadian Manufactured

RADIANT HEATERS



Schwanck
www.schwankgroup.com

Infrared Heaters

- Gas Fired and Electric Infrared Radiant Heaters
- Tube and Luminous Style Radiant Heaters
- Patio Heaters

HUMIDIFIERS

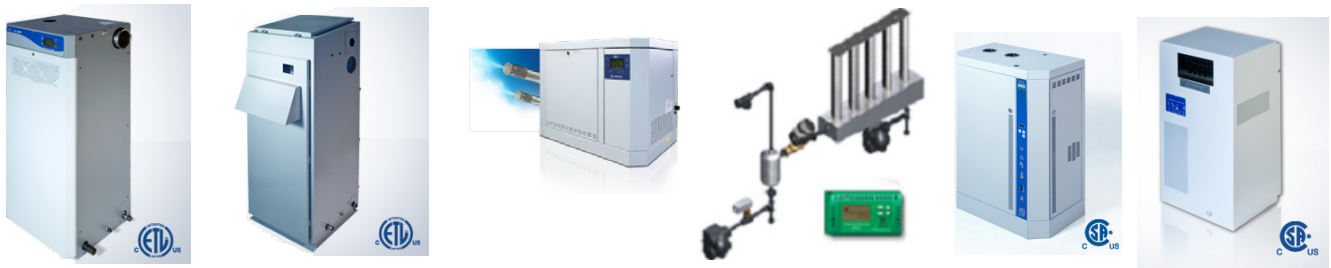

Neptronic
www.neptronic.com

Humidifiers

- Electric
- Gas Fired
- Steam-to-Steam
- Direct Steam
- High Pressure Atomizing
- Evaporative
- Steam Distribution Systems
- Humidity Controls

FLUID & HEAT RECOVERY SYSTEMS



Envirosep Fluid & Heat Recovery Systems
www.envirosep.com

Custom Packages

- Hot Water Systems
- Condensate Handling Systems
- Domestic Water Booster Pump Packages
- Flash Recovery and Blowdown Systems
- Heat Transfer Systems
- Chilled Water Packaged Pumping Systems
- Steam Pressure Reducing Stations
- Steam Trap Stations
- Process Cooling Systems
- Industrial Process Solutions
- Wastewater Heat Recovery
- Reverse Osmosis and Fluid Recovery Systems
- Deareator and Boiler Feedwater / Condensate Handling
- Industrial Controllers
- Industrial Control Panels

FLUID CONTROL

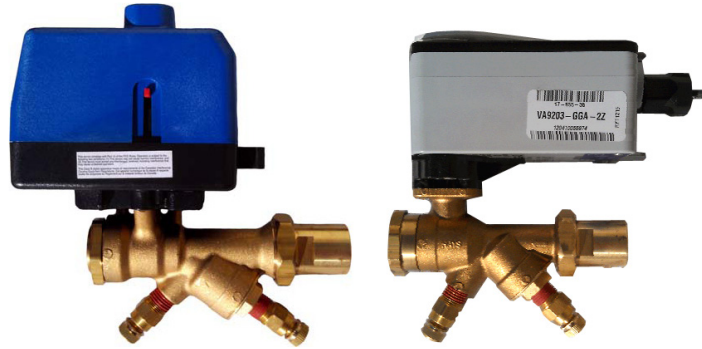

Hays Fluid Control
www.haysfluidcontrols.com

Flow Controls

- Manual and Automatic

Hose Kits & Piping Packages

- Fully Assembled and Tested
- Solenoid Valves

**Custom-Designed Fluid Control
Products for a Wide Range of Unique
Applications**

GAS METERS & REGULATORS



Elster American Meter
www.elster-americanmeter.com

Gas Meters & Regulators

INDUSTRIAL HOSE & EXPANSION JOINTS



Metraflex
www.metraflex.com

Flexible Metal Hose
Metal Expansion Joints
Rubber / Elastomer Expansion Joints

Thermal & Seismic Expansion Joints

CRITICAL ENVIRONMENT COOLING SOLUTIONS



APC By Schneider Electric
www.apc.com

Cooling Solutions for:

- Data Centers
- Server Rooms
- Wiring Closets

Data Center Racking Systems & Accessories
Security & Environmental Solutions for Data Centers

COMPRESSED AIR & AUXILIARIES



Curtis Air Compressors
www.fscurtis.com



Pneumatech-Conservair
www.pneumatech.com

Compressors

- Rotary Screw and Reciprocating
- Oil-Free Screw and Oil-Less Reciprocating
- Climate Control

Refrigerated Dryers

- Desiccant and Blower Purge Dryers

Vacuum Pumps

Accessories

- Air Line Filters and Accessories
- Flow Controllers
- Air Accessories

Controllers

- Intermediate Pressure Control
- Flow Controllers / Demand Expanders
- Refrigerated Air Dryers
- Desiccant Air Dryers
- Compressed Air / Gas Filters
- Condensate Management

COMPRESSED AIR PIPING



Legris Transair
www.parkertransair.com

Compressed Air Piping

- Quick Connection Fluid and Air Piping Systems
- Compressed Air / Vacuum / Fluids / Liquids / Inert Gases
- Stainless Steel for Liquid Applications
- Push to Connect Fittings
- Aircraft Aluminum Pipe with Composite Fittings
- Clean Air Quality
- Corrosion Free

CONTROLS



PRICE | CONTROLS

Price Industries Limited
www.priceindustries.com



Carrier

Carrier
www.carrier.com

DDC Controls

- Networked or Stand-Alone Controls
- BACnet Compatible – BTL Certified

Electronic Stand-Alone Controls

Pneumatic Stand-Alone Controls

Control Applications

- Single Duct Controls
- Fan Powered Controls
- Hydronic Controls
- Bypass Controls
- Underfloor Controls
- Rooftop Controls
- Prodigy Smart Diffusers
- Graphical User Interface

Fully Integrated Light Commercial & Commercial DDC Systems

- Operator Interface
- Programmable Controllers
- Zoning Systems
- Network Devices
- Sensors



BELIMO

Belimo
www.belimo.ca



Honeywell
ANALYTICS

Honeywell Analytics
www.honeywellanalytics.com

Control Valves

- Electronic Control Valves
- Zone Control Valves
- Globe Valves
- Butterfly Valves

Actuators

Monitors, Controllers & Hand Held Products

CONTROLS



Neptronic
www.neptronic.com

Actuated Valves

- Ball Valves
- Butterfly Valves
- Zone Valves
- Globe Valves
- Retrofit Valves

Actuators

HVAC Controls

- Fan Coil Controls
- VAV Controls
- BACnet / Modbus I/O Board

- Wall Mounted Controllers
 - IAQ, Humidity, VAV, Fan Coil, Heat Pump, Make-Up Air and Rooftop Unit
- IAQ Room Sensors
- Temperature and Humidity Sensors

VFDs & STARTERS



Franklin Control Systems
www.franklin-controls.com

HVAC Specialty Products

- Building Automation Starters
- Standard Automation Starters
- Cooling Tower Controls
- Kitchen Hood Controls
- Pump and HVAC Controls

Industrial Products

- Contactors and Overload Relays
- Manual Motor Starters
- Circuit Breakers
- Starters
- Soft Starters
- Soft Starters with Integrated Bypass

- Programmable Logic Controllers
- Terminal Blocks
- Pilot-Devices
- Enclosures



PRESSURE GAGES & METERS



Dwyer
www.dwyer-inst.com

Pressure Gages & Manometers

- Air Velocity Meters
- Flow Transmitters, Sensors, Meters and Indicators
- Level Indicators, Detectors and Controllers
- Temperature Controllers
- Valves
- Air Quality Instruments
- Hazardous Rated
 - Valves
 - Temperature Transmitters
 - Pressure Switches
 - Flow Products
 - Level Models
 - Pressure Transmitters
- Test Equipment

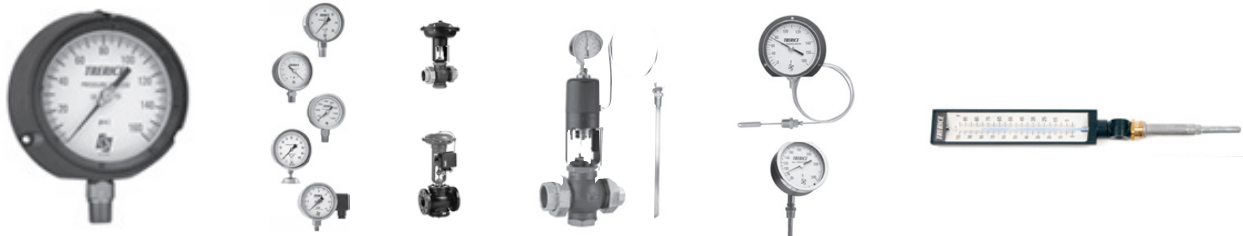

Trerice
www.trerice.com

Pressure Gages

Temperature Instrumentation

Regulators & Control Valves

E.H. PRICE REGINA

703 Toronto Street, Regina, SK S4R 8G1

Ph: 306.525.2367 Fax: 306.359.7988

regina@ehpricesales.com

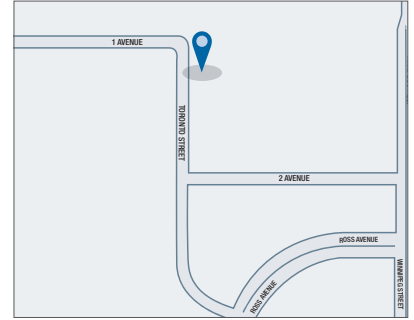
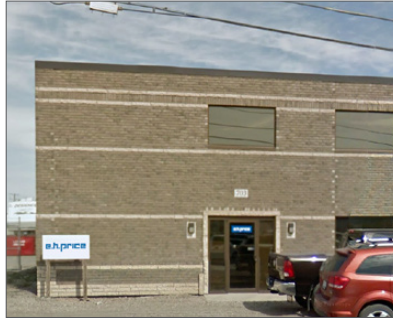

E.H. PRICE SASKATOON

#500 – 3530 Millar Ave, Saskatoon, SK S7P 0B6

Ph: 306.931.3316 Fax: 306.931.0914

saskatoon@ehpricesales.com

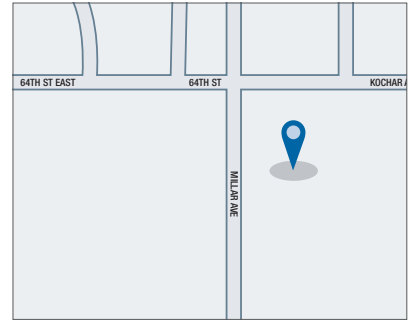

LOCAL DELIVERY AVAILABLE

Specifications are subject to change without notice. Consult your E.H. Price sales representative for current specifications or more detailed information.

Warranty: The Company warrants and guarantees that all goods within this brochure that have been manufactured by the Company have been manufactured in accordance with the specifications published herein and will be free from defects in material and workmanship for a period of twelve (12) months from the Bill of Lading issued by the Company. The Company will replace defective product at its option, but will not be responsible for labor or material charges in replacing product or consequential damages. Any installation not conforming with the Company's specifications, manuals, bulletins or instructions or any misuse or any modification not authorized by the Company voids this warranty. This warranty is in lieu of all Provincial, State, and Federal statutory warranties and the conditions herein are in substitution and replacement of which warranties, statutory or otherwise.



Air Distribution Division



Industrial Division



Mechanical Division

First in Quality, First in Service
www.ehpriceregina.com www.ehpricesaskatoon.com

